



INSTALLATION INSTRUCTIONS **TARASAFE – SHOWER & WET AREAS**

These instructions are specifically written for the installation of the following products:

Product	Width	Thickness	Installation direction	Seam treatment
Tarasafe H2O	Approximately 6' 6"	2mm	Same	Heat Welded
Tarasafe Ultra	Approximately 6' 6"	2mm	Same	Heat Welded

Important Note: Before installing, refer to 2023 Gerflor USA Installation Handbook for acclimation, job site conditions, subfloor prep, and other general installation recommendations.

1. GENERAL INFORMATION

- 1.1. Gerflor flooring products are formulated to withstand high moisture conditions. To perform as designed, the concrete should be properly prepared to create a contaminate free and porous substrate.
- 1.2. Gerflor flooring products are not designed to withstand hydrostatic or osmotic pressure.
- 1.3. *The guidelines offered within this document are not intended to be all inclusive. Only qualified, professional flooring technicians experienced in the field of resilient flooring should proceed with this installation system.*
- 1.4. It is recommended to mechanically prepare the concrete via grinding or bead blasting the surface to achieve a CSP 1+, clean and porous substrate.
- 1.5. Moisture and pH testing must be performed in accordance with ASTM F710-17.
- 1.6. Adhesive bond tests are recommended to ensure adequate bonding to the substrate.
- 1.7. Do not install material that has visible defects or damage. A contractor that installs material that has visible defects or damage assumes responsibility for that material.

2. LAYOUT AND INSTALLATION

- 2.1. Mark the center starting line.
- 2.2. Follow roll sequence numbers.
- 2.3. Unroll the first length of material along this chalk line and then work progressively outward, leaving a 1/4" gap between the sheets and allow the material to relax for a minimum of 16 hours.
- 2.4. Seaming should be kept to a minimum and avoid cross seams as much as possible. Place seams in areas exposed to the least amount of traffic.
- 2.5. For proper heat welding, reposition sheets for a gap no greater than a 1/32" gap between. **Wider gaps will compromise the integrity of the weld.**
- 2.6. In most cases, factory edges can be used for side seams. Sheets that may have minor edge damage or distortion must be trimmed and removed prior to installation of the sheets.
- 2.7. Leave material 4"-6" longer on each end for trimming after placement. *Do not net cut material to the final trim until being placed into the adhesive.*
- 2.8. Before applying the adhesive, ensure gap between the sheets is uniform and no greater than 1/32" along the entire length. Overlap edges and underscribe if necessary, to achieve consistent seam gap. This gap will act as a guide for the groover when preparing to heat weld.

INSTALLATION INSTRUCTIONS TARASAFE – SHOWER & WET AREAS

3. INSTALLING USING GERFLOR T-111 2-PART PU ADHESIVE

Note: T-111 is recommended to be used for areas subjected to excessive topical water and heavy rolling loads. Do not allow any traffic for 16 hours after the installation for adhesive to cure.

- 3.1. Always refer to the **Gerflor T-111 Polyurethane Adhesive Technical Data Sheet**.
- 3.2. The recommended trowel size is 1/32" x 1/16" x 1/32" 'U' notch,  covering 170 – 220 sq. ft. per US gallon.
- 3.3. Mix polyurethane adhesive part A and part B as recommended by the adhesive manufacturer.
- 3.4. Installers must be familiar with the use of polyurethane adhesives.
- 3.5. Starting from the center line and working outward, fold the sheets back halfway and apply the adhesive to the subfloor.
- 3.6. Installer may also use the "roll back" method. With the roll back method, do not pre-cut material as if to be the final trim. Leave material 2"-3" longer for trimming after placement

Note: Fold back and roll back methods are preferred to the fold lengthwise method. Some areas will dictate the fold lengthwise method.

Rollback method

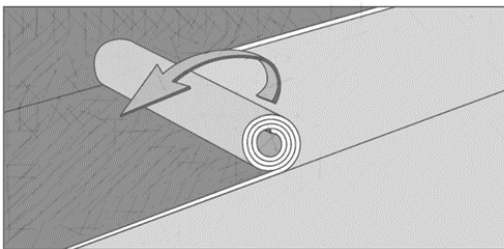

Fold back method

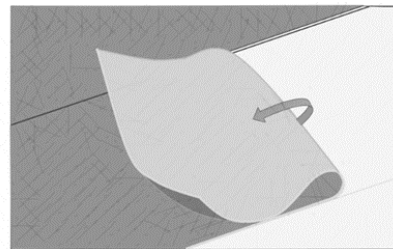

- 3.7. To ensure uniform adhesion of the entire surface, only spread a workable amount of adhesive at one time. Maintain a uniform spread rate. Replace trowel (or trowel blade) with every pail used.
- 3.8. There is no 'open time' needed with this type of adhesive, the flooring must be applied into the wet adhesive within 40 minutes.
- 3.9. While installing, always work to have complete sheets glued at the end of the day.
- 3.10. To reduce the risk of bubbles, the roll back method is the most recommended.
- 3.11. By keeping the roll tight and maintaining a constant pressure while unrolling into the adhesive, the risk for bubbles will be minimal.
- 3.12. The fold back method is acceptable, but care must be taken to not flap it back too quickly.
- 3.13. Always roll seams, at the walls, and under toe kicks with a hand roller to ensure 100% transfer of adhesive.
- 3.14. Do not stand, kneel, or walk on the sheet vinyl flooring. The use of kneeling board and walking board is mandatory to eliminate adhesive displacement.
- 3.15. Adhesive transfer must be **100% wet transfer** to the backing of the flooring. Trowel ridge marks should not be visible on the back of the flooring or on the subfloor. Use weights if needed for end seams or perimeters. If the adhesive skins over or dries it must be scraped up and new adhesive applied.

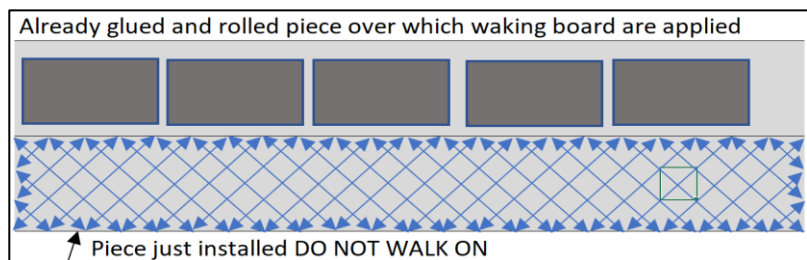

INSTALLATION INSTRUCTIONS TARASAFE – SHOWER & WET AREAS

- 3.16. Care must be taken to avoid flopping the sheets into the adhesive as this may cause air to become entrapped
- 3.17. Continue laying sheets by keeping the edges spaced no greater than 1/32", trimming each side with a straight edge or scribing. The goal is to produce a uniformly 1/32" spaced seam for welding.
- 3.18. Using a 100-lbs sectional steel roller, roll the flooring in the width first and then the length to ensure adhesive transfer and to evacuate all air that can lead to bubbles. Optimally there should be an individual tasked solely with this responsibility
- 3.19. Continually check the flooring for bubbles. To verify there are no bubbles, look down and across the flooring from both a standing and prone position with the lights on and off. The use of a light source at floor level can be helpful in finding any air pockets or bubbles.
- 3.20. **Avoid adhesive displacement by prohibiting ALL traffic for a period of 16 hours and 36 hours for rolling loads.**
- 3.21. **The use of walking 4' x 8' x 1/4" Masonite boards and kneeling boards are mandatory to protect from adhesive displacement during installation.**

4. SHOWER/WET AREA INSTALLATION RECOMMENDATIONS

NOTE: Tarasafe H2O is the only product approved for shower applications

NOTE: T-111 adhesive is the only adhesive approved for shower or wet area installations

If subfloor moisture is above 85% RH, a topically applied two-component epoxy moisture mitigation system should be used prior to the application of T-111 adhesive. Follow manufacturer recommendations for Proper application of the system.

NOTE: Never use topical waterproofing compounds that are designed for use beneath ceramic or stone applications. Gerflor can take no responsibility for adhesive compatibility or bond performance if these products are used.

4.4. Drain Recommendations

- 4.4.1. When installing Tarasafe in showers or wet areas, a surface membrane clamping drain is recommended such as the FD-100-FC seen below, or similar.

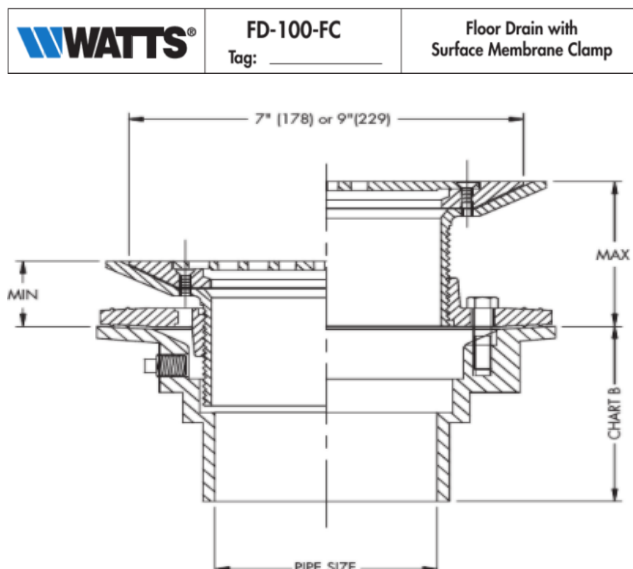

INSTALLATION INSTRUCTIONS TARASAFE – SHOWER & WET AREAS

- 4.4.2. The body and adjustable height clamping insert must be installed flush appropriately so it will be flush with the flooring.

NOTE: Additional sloping toward the drain may be necessary for proper drainage. Check with current local construction guidelines for sloping requirements.

- 4.4.3. Never position a seam over the drain. Seams should be a minimum of 6 inches from the edge of the drain.

- 4.4.4. Mark the inside edge of the flange/cover to ensure there will be enough flooring beneath when the flange is screwed down after the adhesive is cured.

- 4.4.5. Cut the flooring on mark and install the flooring using T-111. Weight down overnight with sandbags or similar, to ensure adequate bonding.

- 4.4.6. Allow adhesive to cure for a minimum of 16 hrs. and then heat up flooring around the drain.

- 4.4.7. While the flooring is still warm, install the flange or cover using the screws.

- 4.4.8. The screws must go through the flooring

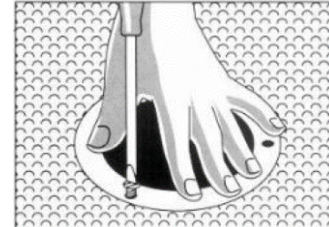
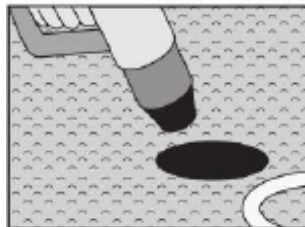
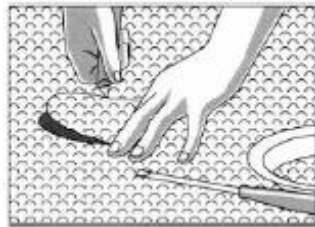
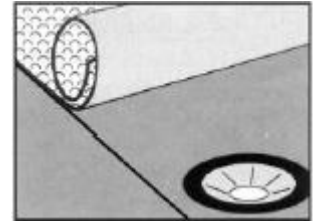

5. FLASHCOVING – SHOWER APPLICATIONS

Note: There are many different wall surfaces used in showers such as ceramic tiles, or rigid PVC panels so every job needs to be evaluated for the best performance of the shower system. Water must be controlled and every attempt to prevent water from entering behind the flooring should be implemented. **When installing in shower applications there must be an “overlap” design between the wall surface and the flooring to protect against water intrusion. Contact Gerflor Technical for further recommendations if needed.**

Note: For better results with flash coving, the walls must be built sound and solid down to the subfloor. There must not be any voids present at the bottom of the wall. Ensure all surfaces to be installed on are smooth and free of contaminants.

- 5.1. Metal cove cap is preferred to vinyl cap.
- 5.2. Miter all corners cleanly. Outside corners should be cut and shaped from a solid piece of aluminum cap.
- 5.3. Affix cove stick securely to the floor and wall. Contact tape, staples, and contact cement are commonly used for this.
- 5.4. The flooring material can be either pattern scribed or cut in by hand.

INSTALLATION INSTRUCTIONS TARASAFE – SHOWER & WET AREAS

- 6.5. Outside corners can be formed using the “butterfly” method. Use contact tape or contact cement to secure to the wall

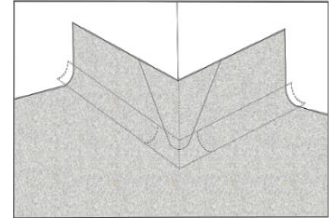
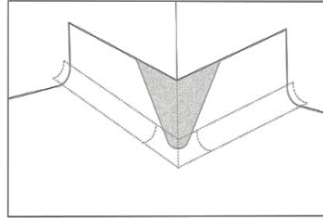

- 6.6. While installing the outside corners, it may be necessary to heat to shape the material.

- 6.7. Always install the outside corner piece first.

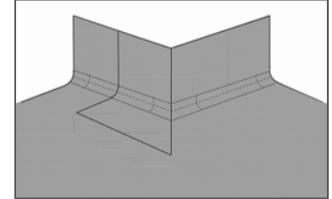
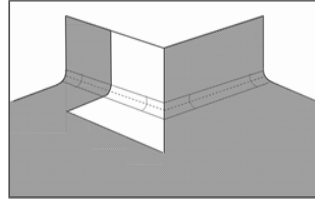

- 6.8. The “boot” outside corner method is also acceptable along with border coving, or picture framing to create accent borders.

- 6.9. Inside corners can be cut at a 45° angle on the wall or with a 90° vertical seam in the corner

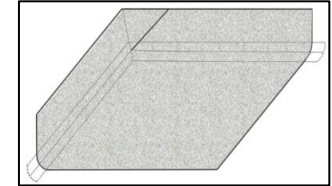
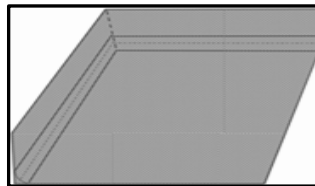

- 6.10. Straight walls are adhered with T-111 from the floor, over the cove stick, and up the wall.

- 6.11. **Use a one-inch piece of contact tape adhered to the wall directly beneath the adjoining wall surface at the top of the vinyl “cove” area.**

- 6.12. **Leave the scrim on the tape while spreading the T-111 on the wall surface first and then the floor.**

- 6.13. **Lay flooring into the adhesive, remove tape scrim, and apply heat to the surface of the vinyl at the radius of the cove stick then firmly press to ensure it is in contact with the cove stick.**

- 6.14. Roll cove area and wall with a hand roller and then secure the vinyl to the contact tape, trim and tuck under any vertical wall covering or substrate to ensure an overlap design.

Note: The one-inch band of contact tape at the upper edge of the cove area is highly recommended to ensure the vinyl stays down tight at the radius of the cove stick while the T-111 adhesive cures.

- 6.15. Use a high-quality sealant under the overlap area where the wall surface meets the vinyl to ensure it is completely sealed. This should be regularly checked and maintained as needed.

- 6.16. **All vertical, inside corner, and outside corner seams must be heat welded.**

6. SHOWER APPLICATIONS WITH SPM WALL PANELS

- 6.1. Always use T-111 to adhere SPM wall panels in shower applications

- 6.2. Always provide an “overlap design of the SPM wall panel over the coved flooring. **(See detail below) Contact Gerflor Technical for further support if needed**

INSTALLATION INSTRUCTIONS TARASAFE – SHOWER & WET AREAS

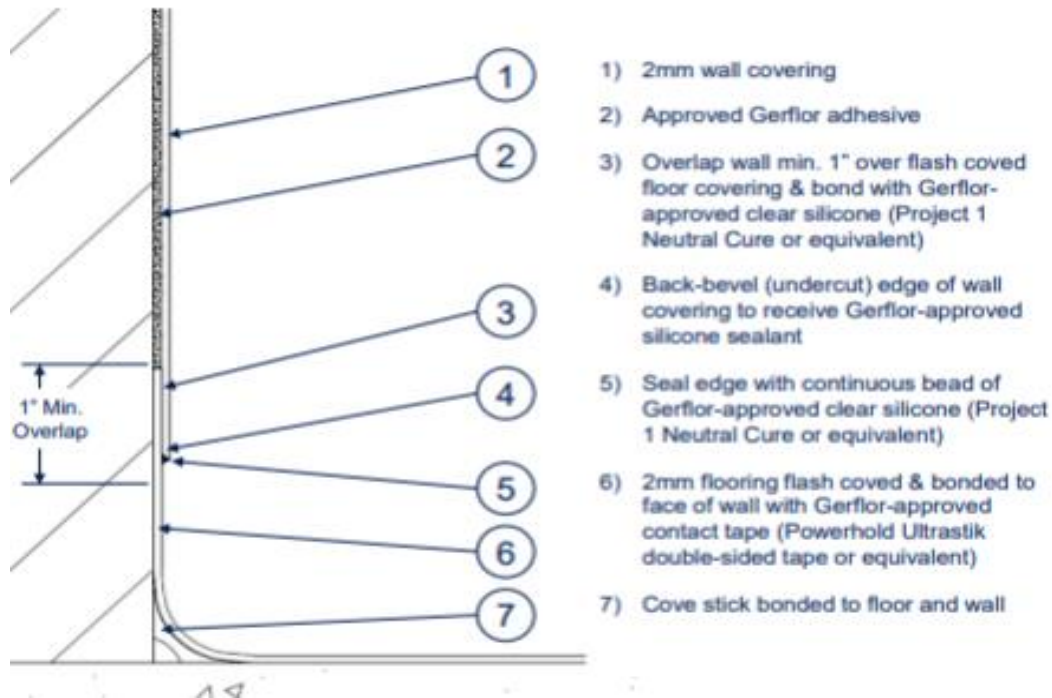

7. HEAT WELDING - REFER TO THE "HEAT WELDING GERFLOR VINYL PRODUCTS" DOCUMENT

8. ONCE THE INSTALLATION IS COMPLETED

- 8.1. Clean the area to verify there are no imperfections, adhesive residue, scuff marks, etc. Verify every welded seam.
- 8.2. Make sure that the vinyl is well trimmed and sealed with a silicone sealer (or equivalent) around all fixed, vertical objects (e.g., doorways, posts, etc.).
- 8.3. To maximize the aesthetic appearance and serviceability of the newly installed flooring, provide your customer with a copy of the **Gerflor USA Maintenance Instructions**: